

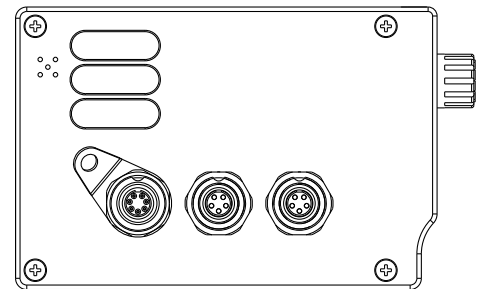

SmartyCam 3 Corsa

On-board camera

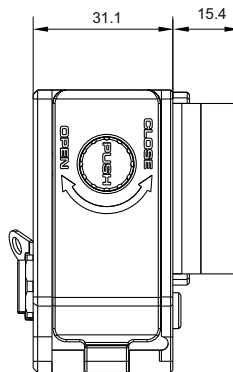

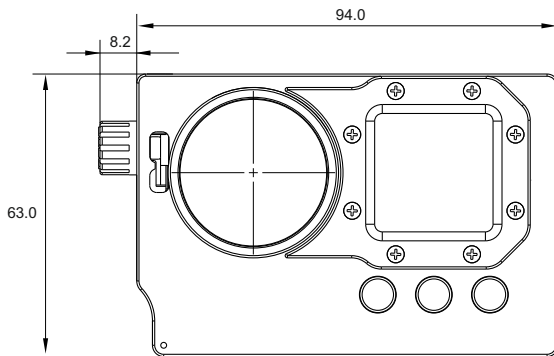
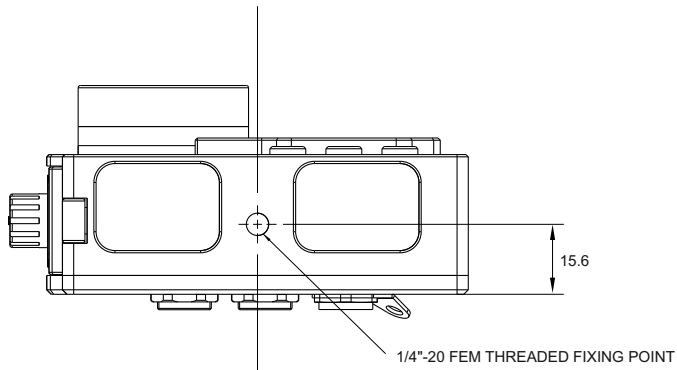

SmartyCam 3 Corsa

On-board camera

Pinout

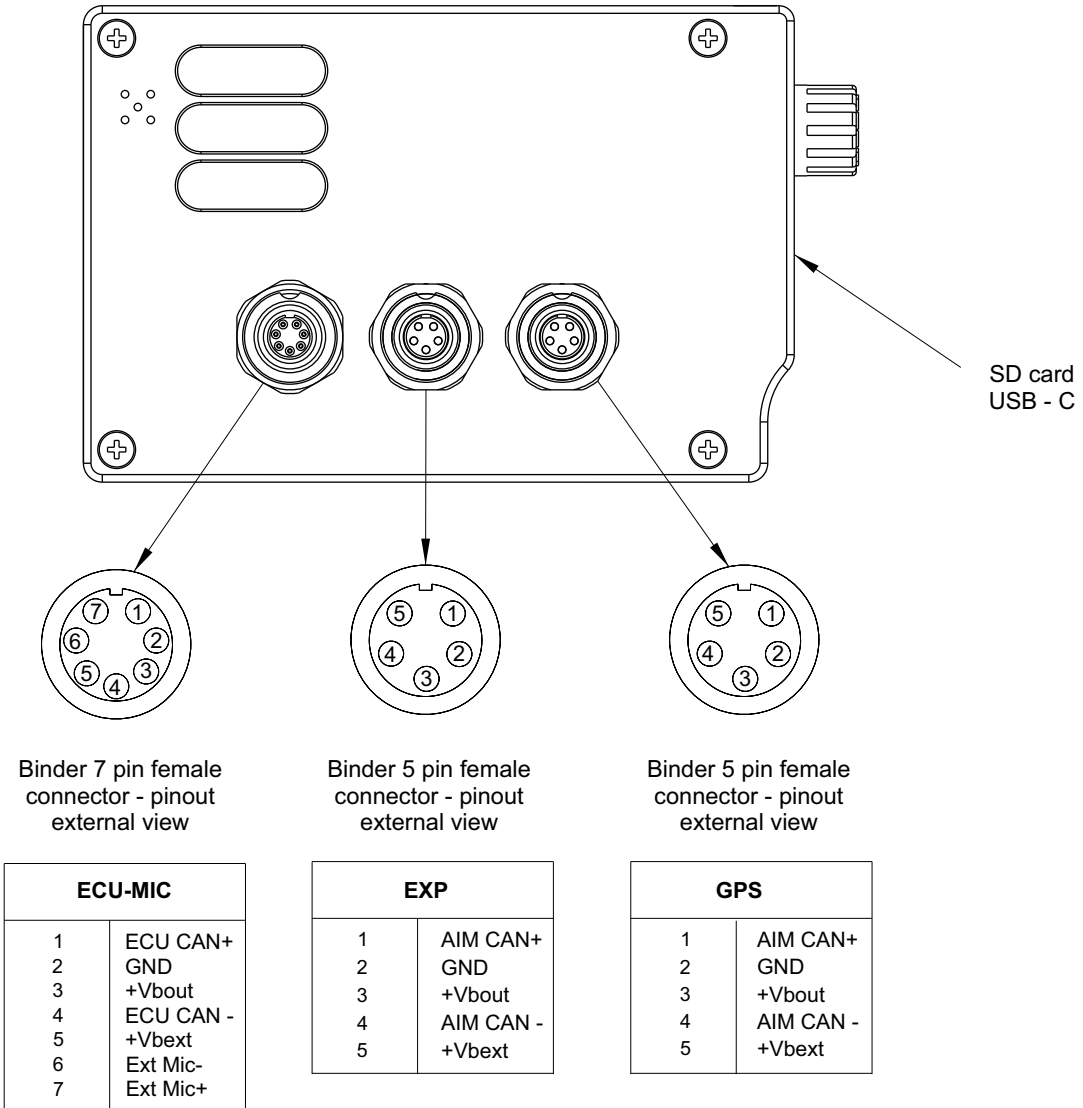



SmartyCam 3 Corsa

On-board camera

Technical characteristics

Video format	H.264 1920 x1080 pixels @ 60 fps
Display resolution	128 x 128 pixels
Lens	Low distortion camera lens
CMOS sensor	Global Shutter
Field of view	67° or 84°
Internal battery	Rechargeable lithium battery
External power	9-15 Volt
Supported SD card	Up to 2 TB
Connectors	3 Binder 712 female 1 USB-C
Usage temperatures	-10°C/+50°C
Auto Power ON	Yes
Auto Power OFF	Yes
Auto Start/Stop Recording	Yes
Dimensions	102.2 x 63 x 46.5 mm
Weight	280 g, battery included
Waterproof	IP65







SmartyCam 3 Corsa





On-board camera

Kits, accessories & spare parts





Kit 1 SmartyCam 3 Corsa 67° lens CAN 2 m

Description	Part number*	The kit contains			
SmartyCam 3 Corsa CAN 2 m 67° lens	XS3CRFHD06700 □	SmartyCam 3 Corsa (67° lens) 	Battery charger with AC adapter 	CAN Expansion cable 2 m 	USB 2.0 Type A cable 





Kit 2 SmartyCam 3 Corsa 67° lens CAN 4 m

Description	Part number*	The kit contains			
SmartyCam 3 Corsa CAN 4 m 67° lens	XS3CRFHD06701 □	SmartyCam 3 Corsa (67° lens) 	Battery charger with AC adapter 	CAN Expansion cable 4 m 	USB 2.0 Type A cable 

Kit 3 SmartyCam 3 Corsa 67° lens CAN ECU 2 m

Description	Part number*	The kit contains			
SmartyCam 3 Corsa CAN ECU 2 m 67° lens	XS3CRFHD06793 □	SmartyCam 3 Corsa (67° lens) 	Battery charger with AC adapter 	CAN ECU cable 2 m 	USB 2.0 Type A cable 

Kit 4 SmartyCam 3 Corsa 67° lens CAN ECU 4 m

Description	Part number*	The kit contains			
SmartyCam 3 Corsa CAN ECU 4 m 67° lens	XS3CRFHD06794 □	SmartyCam 3 Corsa (67° lens) 	Battery charger with AC adapter 	CAN ECU cable 4 m 	USB 2.0 Type A cable 

* AC Adapter: substitute □ with:

- E** for Europe
- G** for UK
- U** for USA
- A** for Australia







SmartyCam 3 Corsa





On-board camera

Kits, accessories & spare parts





Kit 5 SmartyCam 3 Corsa 84° lens CAN 2 m

Description	Part number*	The kit contains			
SmartyCam 3 Corsa CAN 2 m 84° lens	XS3CRFHD08400 □	SmartyCam 3 Corsa (84° lens) 	Battery charger with AC adapter 	CAN Expansion cable 2 m 	USB 2.0 Type A cable 





Kit 6 SmartyCam 3 Corsa 84° lens CAN 4 m

Description	Part number*	The kit contains			
SmartyCam 3 Corsa CAN 4 m 84° lens	XS3CRFHD08401 □	SmartyCam 3 Corsa (84° lens) 	Battery charger with AC adapter 	CAN Expansion cable 4 m 	USB 2.0 Type A cable 

Kit 7 SmartyCam 3 Corsa 84° lens CAN ECU 2 m

Description	Part number*	The kit contains			
SmartyCam 3 Corsa CAN ECU 2 m 84° lens	XS3CRFHD08493 □	SmartyCam 3 Corsa (84° lens) 	Battery charger with AC adapter 	CAN ECU cable 2 m 	USB 2.0 Type A cable 

Kit 8 SmartyCam 3 Corsa 84° lens CAN ECU 4 m

Description	Part number*	The kit contains			
SmartyCam 3 Corsa CAN ECU 4 m 84° lens	XS3CRFHD08494 □	SmartyCam 3 Corsa (84° lens) 	Battery charger with AC adapter 	CAN ECU cable 4 m 	USB 2.0 Type A cable 

* AC Adapter: substitute □ with:

E for Europe

G for UK

U for USA

A for Australia





SmartyCam 3 Corsa





On-board camera

Kits, accessories & spare parts

Accessories

Bracket kits	Part number	
Suction cup kit In the box: suction cup + clamp base with ball + 60 mm single ball arm + Ball head + washer diameter 17.7mm, thickness 1.5mm, hole 6mm	X90KSSMC1	
Kit for 1 to 2.1 inches Ø bar In the box: Handlebar bracket + straps + 60 mm single ball arm + Ball head + washer diameter 17.7mm, thickness 1.5mm, hole 6mm	X90KSSMC0	
Kit for 0.5 to 1.2 inches Ø bar In the box: U-bolt + straps + 60 mm single ball arm + Ball head + washer diameter 17.7mm, thickness 1.5mm, hole 6mm	X90KSTP00	

Spare Parts

Description	Part number	
Lens glass replacement kit	X98KVOCHD0	
Display glass replacement kit	X98KVDCHD0	
CAN Expansion cable 2 m 4 m	V02554820 V02554830	
CAN ECU cable 2 m 4 m	V02566930 V02566940	
USB 2.0 Type A cable	X90TMPC101010	
Battery charger with AC adapter AC Adapter: substitute □ with E for Europe, G for UK, U for USA, A for Australia	X06A12VBM □	