

AiM User guide

Kit for Solo 2DL on
Suzuki RMZ – 4 stroke
250 cc 2010-2013
450 cc 2008-2013

Release 1.00



KIT



1 Models and years

This manual explains how to connect Solo 2DL to Suzuki RMZ Engine Control Unit (ECU). Supported models are:

- Suzuki RMZ 250cc – 4 stroke 2010-2013
- Suzuki RMZ 450 cc – 4 stroke 2008-2013

2 Kit content and part number

Suzuki RMZ – 4 stroke – 2008-2013 AiM kit for Solo 2DL part number is: **V02569240CS1**. The kit – shown here below – contains:

- 1 Bar Pad for bikes without cross brace for Solo 2DL with thermoformed cover and Velcro already mounted (1)
- 1 fixing plate (2)
- 4 Allen screw (3)
- 1 Allen key (4)
- 1 cable for Suzuki RMZ 2008-2013 (5)



Suzuki RMZ cable (5) – part number **V02569240** – and Bar Pad for Solo 2DL (1) – part number **X47PSOLO2T10** – can be bought separately as spare parts.

The draw here below shows constructive scheme of cable **V02569240**.

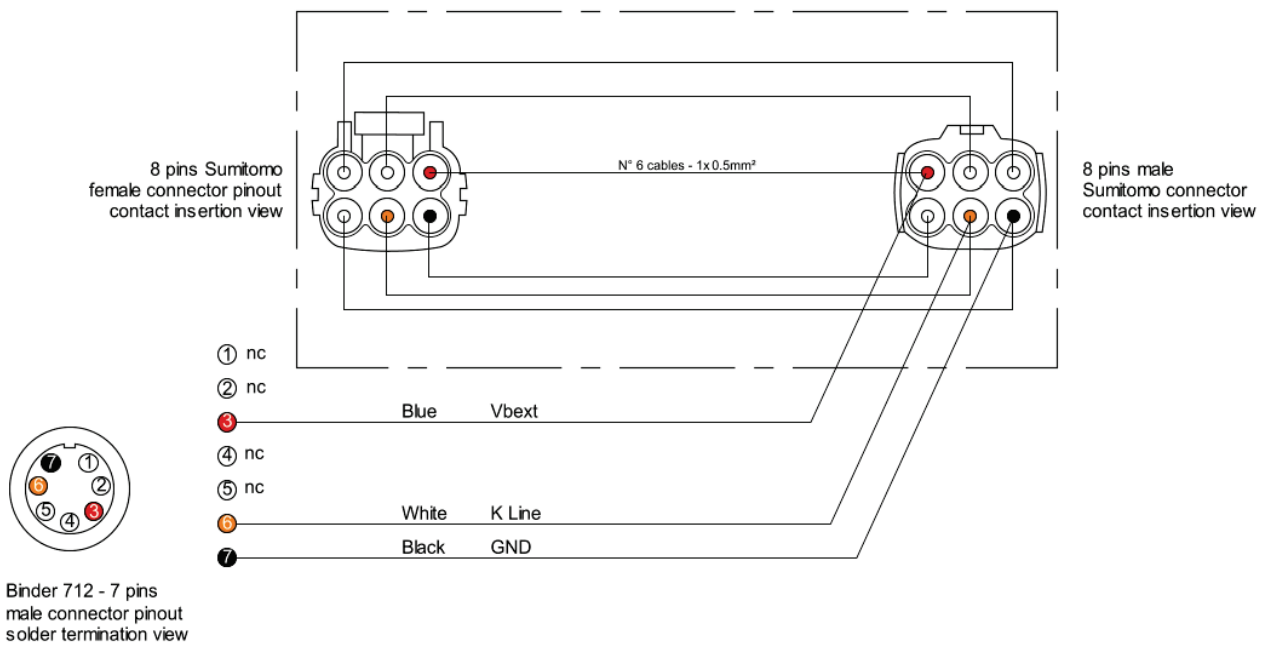

3

Installation and connection

To install Solo 2L on your Suzuki RMZ remove the original bar pad and install AiM pad following the instructions you can download from www.aim-sportline.com – download documentation Area. Images here below show the original bar pad on the left and AiM one on the right.



3.1

Installation and connection on Suzuki RMZ 2013

To connect Solo 2DL to your bike ECU use SDS connector you find behind the bike radiator and shown here below. Pull it down along the metallic tongue highlighted in the image below on the left until you have the result shown on the right.

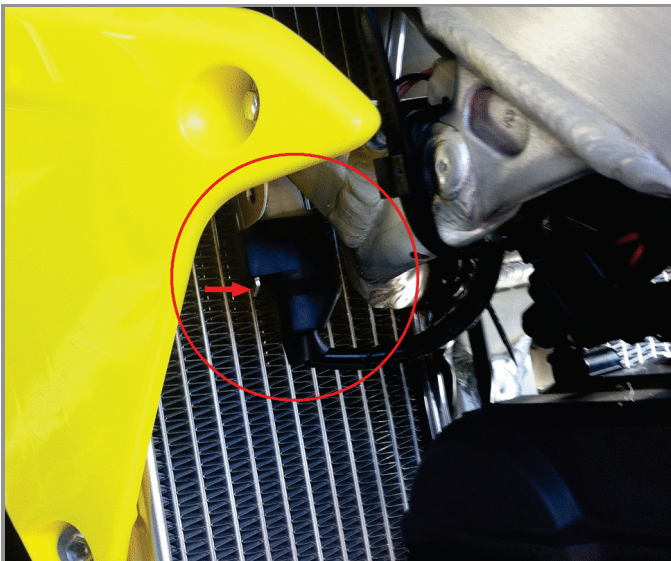

Remove the black rubber cap sliding it along the cable as shown here on the right.

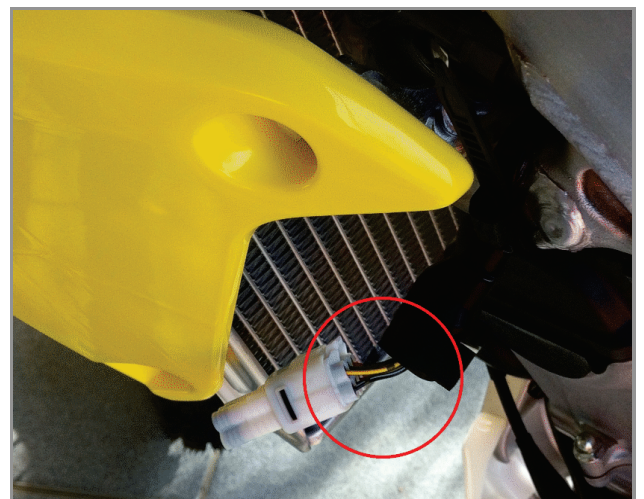

Unplug Suzuki cable as shown here below and in the image.

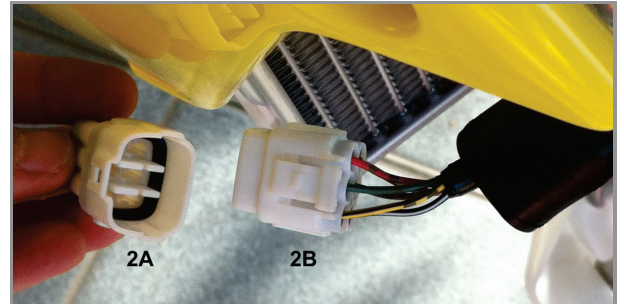
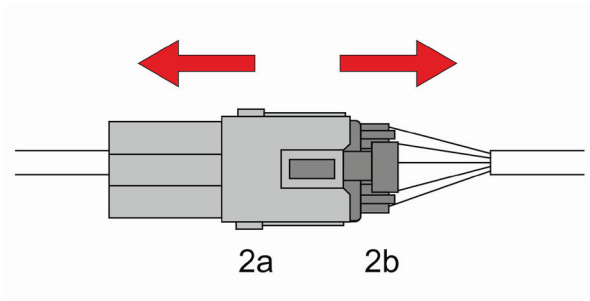

Plug AiM cable (1) in the connectors shown here above (2a and 2b) as in the scheme below. This way you can continue managing different Suzuki original ECU maps.

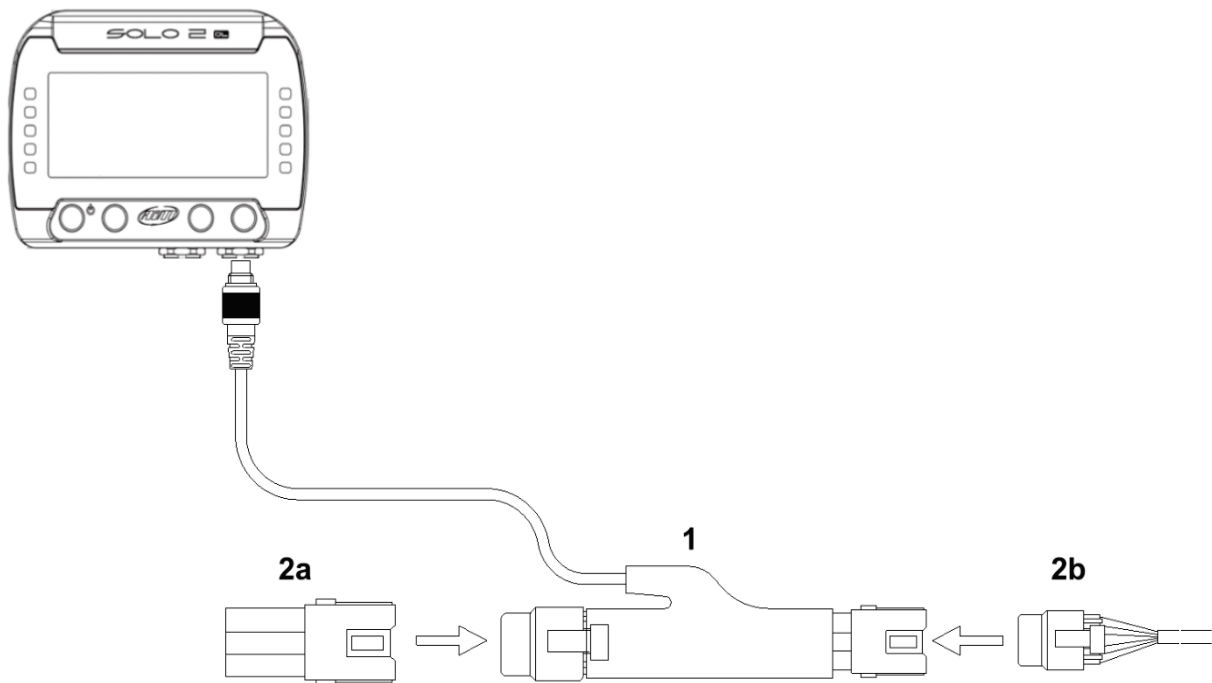

Replace the cap you removed and shown below on the left. Open the rubber band "E" shown below on the right, insert cable "F" of AiM wiring and close the band.

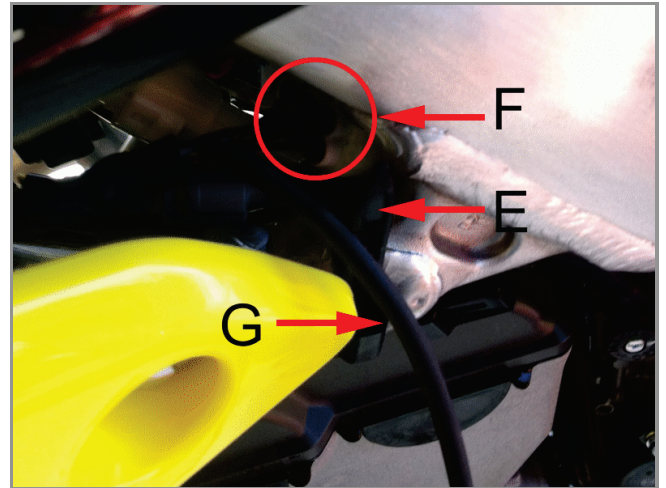
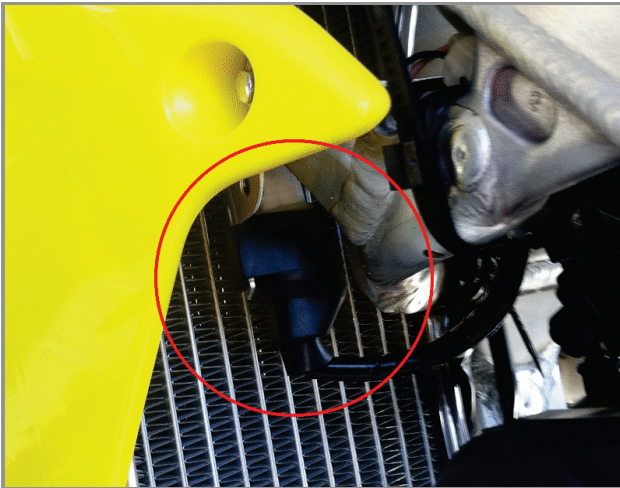

Make cable "G" of the image above on the right pass through the bike radiator, along the chassis as shown below on the left. Band it with the other cables highlighted below on the right.

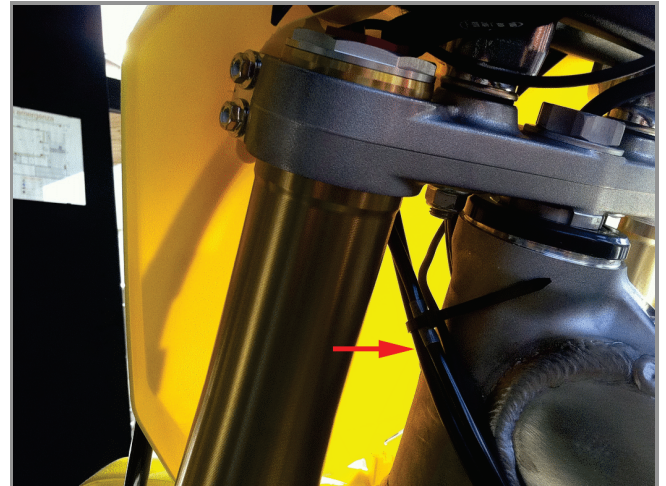

Images below show the cable free on the left and banded on the right.

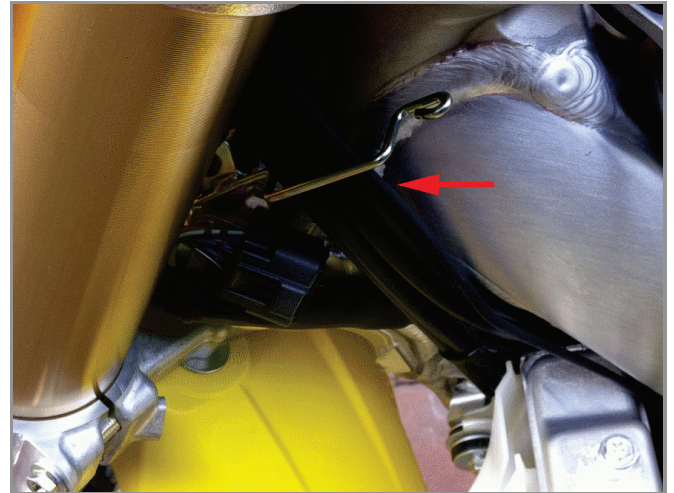
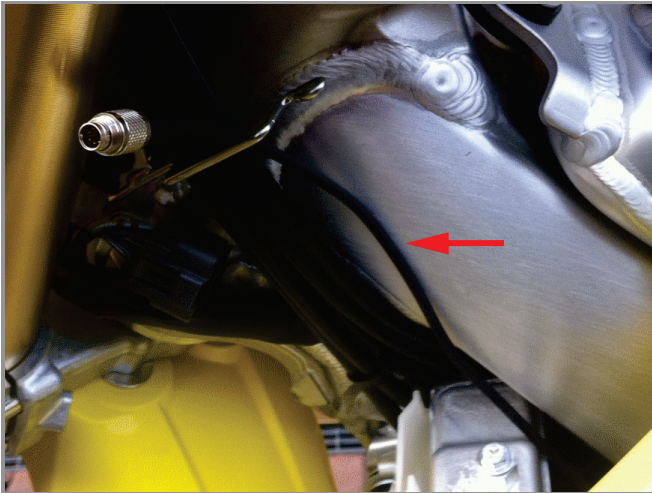

Make AiM cable pass around the fork plate ("F" here below on the left) and connect AiM cable to Solo 2DL.

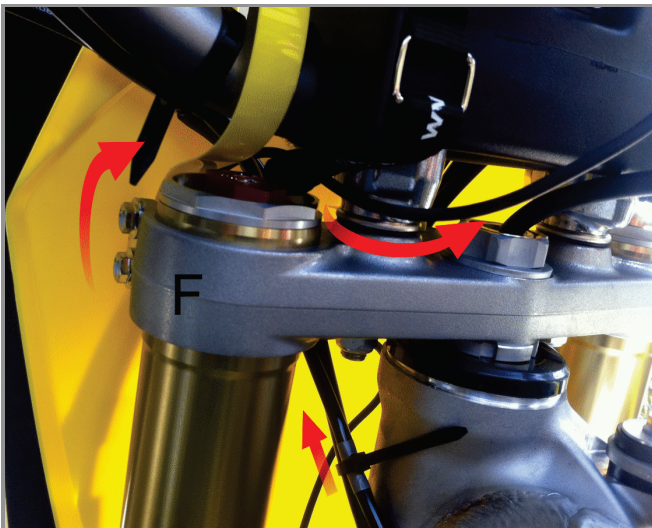

3.2

Installation and connection on Suzuki RMZ 450 cc 2008-2012 and 250 cc 2010-2012

In Suzuki RMZ 450 cc 2008-2012 and 250 cc 2010-2012 bikes the connector – circled in the image on the right – is under the number plate indicated in the image on the left.

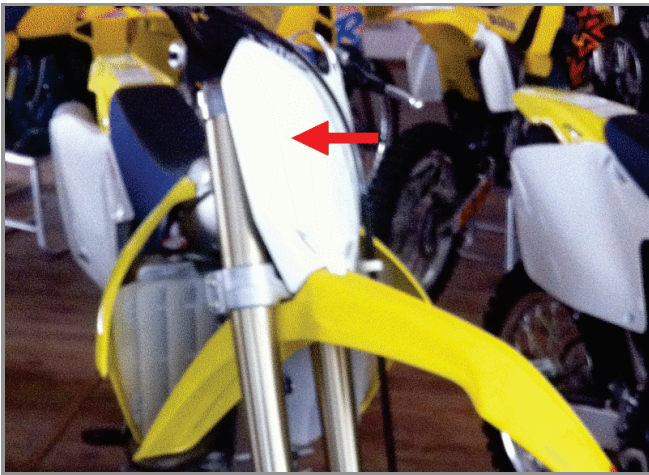

The connection is to be made as explained in the previous paragraph. Once this operation performed, the cable you connected has to pass between the bike plate and the bar pad. Images here below show the cable path.

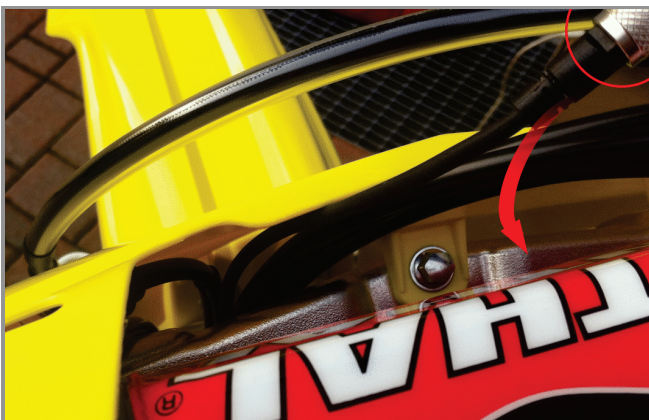

When the metallic connector is plugged in Solo 2DL band the exceeding part of cable: the result is shown here below.

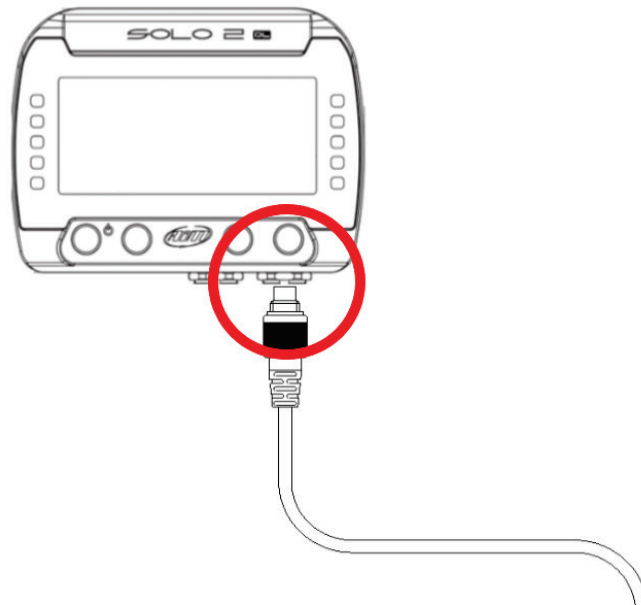

4 Race Studio 3 configuration

Before connecting Solo 2DL to Suzuki RMZ ECU set it up using AiM Race Studio 3 software. The parameters to select in the logger configuration are:

- ECU Manufacturer: **Suzuki**
- ECU model: **RMZ**



5

"Suzuki – RMZ" protocol

Channels received by Solo 2DL configured with "Suzuki - RMZ" protocol are:

CHANNEL NAME	FUNCTION
ECU_RPM	RPM
ECU_TPS	Throttle Position Sensor
ECU_BATTVOLT	Battery supply
ECU_CLT	Engine coolant temperature
ECU_IAT	Intake air temperature
ECU_MAP	Manifold Air pressure
ECU_BAROM	Barometric Pressure
ECU_BOOST	Difference between Manifold Air Pressure and Barometric Pressure

Technical note: not all data channels outlined in the ECU template are validated for each manufacturer model or variant; some of the outlined channels are model and year specific, and therefore may not be applicable.